

DOCK INSTRUCTIONS

QUICK CONNECT

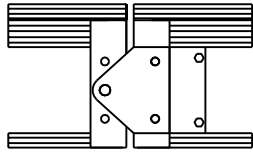

SCREW JACK

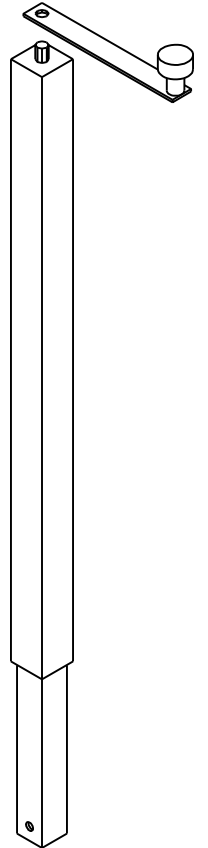

L SECTION DOCK FRAME CONNECTION

INSIDE VIEW

OUTSIDE VIEW

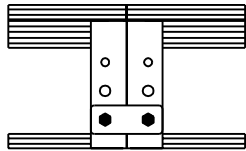
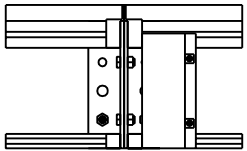

CLAMP POCKET

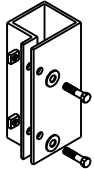

PAD

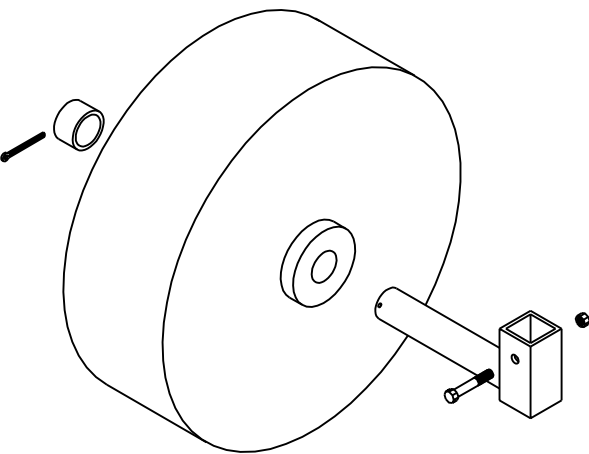
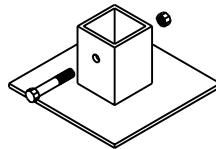

WHEEL & AXLE- INSTALL
IN PLACE OF PAD WHERE
NEEDED